



OWNER'S

MANUAL

ENG

*VENOM-D5.80 IN  
VENOM-D1000 IN  
VENOM-D4.200 IN  
CLASS D AMPLIFIERS*

*PLEASE READ CAREFULLY BEFORE USING*

---



# Venom

The word "Venom" is written in a bold, black, gothic-style font. The letter "V" is significantly larger than the other letters. Below the "V" and the "e", there is a stylized graphic of a mask with red eyes and a white fanged mouth, resembling the Venom character's mask. The mask is positioned centrally, overlapping the bottom of the "V" and the "e".

## INTRODUCTION

Congratulations and thank you for purchasing AurA VENOM series amplifiers, the logical choice in mobile audio amplification. Your amplifiers have been designed and engineered with the highest quality components and top of the line workmanship to help you reach the superior sound you are after.

To achieve optimal performance of your system, please take a few moments to read over this Owner's manual or visit authorized dealer if needed before starting your installation.

## FEATURES

- ◆CLASS D AMPLIFIER
- ◆STABLE INTO 1 OHM LOAD(D1000 IN/D5.80 IN CH5)  
2 OHM LOAD(D4.200 IN/D5.80 IN CH1-CH4)
- ◆HIGH SPEED MOSFET POWER SUPPLY
- ◆12dB/OCT CROSSOVER
- ◆VARIABLE LOW PASS FILTER
- ◆VARIABLE HIGHPASS/SUBSONIC FILTER
- ◆0-12dB VARIABLE BASS BOOST
- ◆REMOTE CONTROL D1000 IN/D5.80 IN
- ◆COMPACT DESIGN

## SPECIFICATIONS

Model	VENOM-D5.80 IN	VENOM-D1000 IN	VENOM-D4.200 IN
RMS power @ 4 ohm	80 W x 4 + 190 W x 1	400 W x 1	201 W x 4
RMS power @ 2 ohm	130 W x 4 + 320 W x 1	600 W x 1	301 W x 4
RMS power @ 1 ohm	500 W x 1(CH5)	1000 W x 1	N/A
RMS power @ 4 ohm(Bridge)	260 W x 2	N/A	602 W x 2
Working impedance	2 ohm stable(CH1-CH4) 1 ohm stable(CH5)	1 ohm stable	2 ohm stable
Input Sensitivity	6 V - 0.2 V	6 V - 0.2 V	6 V - 0.2 V
Low Pass Filter	35 Hz - 250 Hz(CH5)	35 Hz - 250 Hz	40 Hz - 4 KHz
High Pass Filter	15 Hz - 3 KHz(CH1-CH4)	N/A	15 Hz - 3 KHz
Subsonic Filter	N/A	10 - 55Hz	N/A
Bass Boost	0 - 12 dB	0 - 12 dB	N/A
Frequency Response	10 Hz - 250 Hz(CH5) 15 Hz - 30 KHz(CH1-CH4)	10 Hz - 250 Hz	15 Hz - 30 KHz
Signal to Noise Ratio	>85 dB	>85 dB	>85 dB
THD @ 4ohm	< 0.1%	< 0.1%	< 0.1%
Damping Factor	>150	>150	>150
Working voltage	9 V - 15 V	9 V - 15 V	9 V - 15 V
Fuse Rating	80 A	80 A	External
Dimensions ( inches )	12.85 L x 5.87 W x 2.05 H	7.78 L x 5.28 W x 2.05 H	10.54 L x 5.28 W x 2.05 H

All features are subject to change in the continuing effort to improve the products without notice.



## POWER CONNECTION

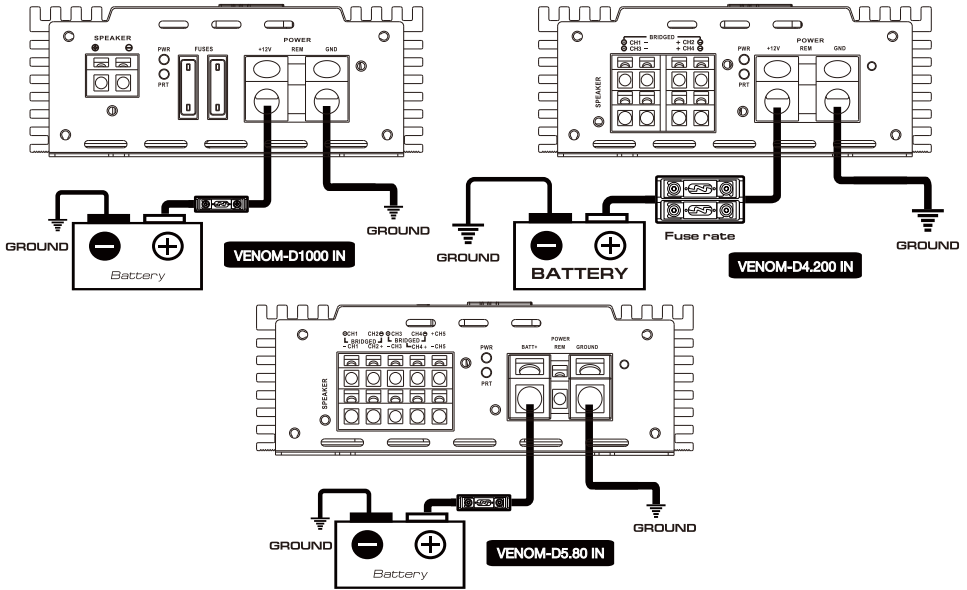

ENG

### BATT (12V POWER)

Before mounting amplifiers, disconnect the negative cable from the battery to protect any accidental damage to your amplifiers and audio system. Connect the power cables to power terminal 12V.

**VENOM-D5.80 IN/VENOM-D4.200 IN** amplifiers are not equipped with fuses so that external fuses should be used.

Connect one end of fuse holder to the power cable going into the amplifiers and the other end of fuse holder to positive battery. This fuse location will protect the system and the vehicle against the possibility of a short circuit in the power cable. Be sure to use fuses and fuse holder adequate for the application.

### GND (GROUND)

Locate a secure grounding connection as close to amplifier as possible. Make sure the location is clean and provides a direct electrical connection to the frame of the vehicle. The ground needs to have as low of a resistance as possible. Connect one end of a short piece of the same size cable as the power cable to the grounding point or to one of your batteries or battery bank. Run the other end of the ground cable to the mounting location of the amplifiers for connection to the amplifiers ground terminals and connect the ground cable to the GND (ground terminal).

### REM (REMOTE)

Run a remote turn on cable from the switched 12V source. This may be a toggle switch, a relay, your source unit's remote trigger cables, or power antenna trigger cable. Connect the remote turn on cable to the REM (remote) terminal.

# RCA INPUT CONNECTION

## VENOM-D1000 IN

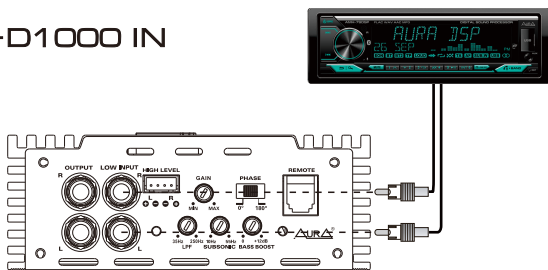

## VENOM-D4.200 IN

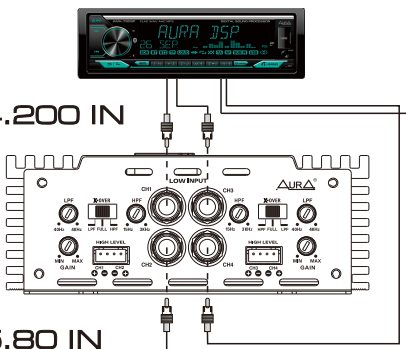

## VENOM-D5.80 IN

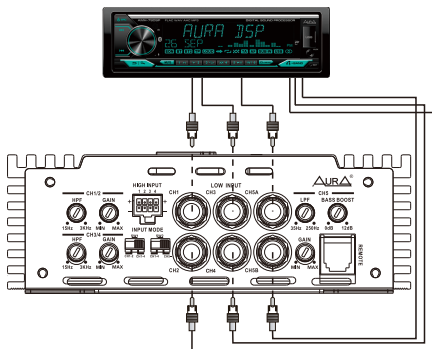
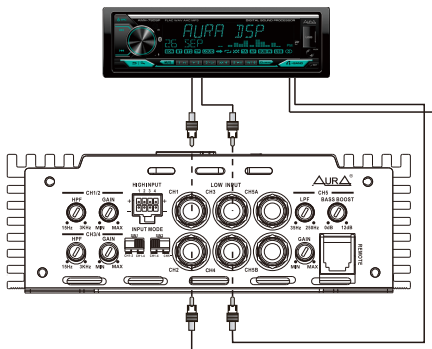
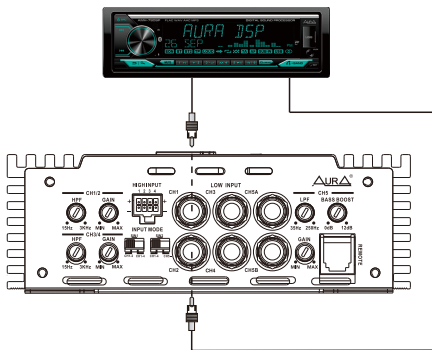

ENG



## SPEAKER CONNECTION

### VENOM-D1000 IN

4 ~ 1 ohm

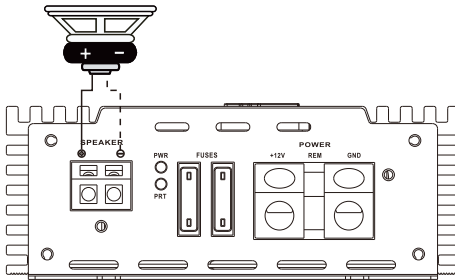

### VENOM-D4.200 IN

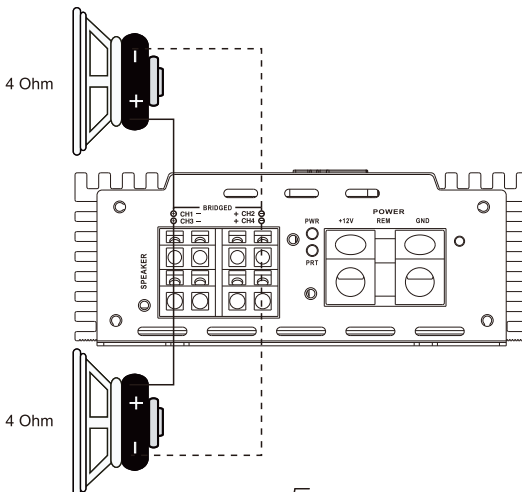
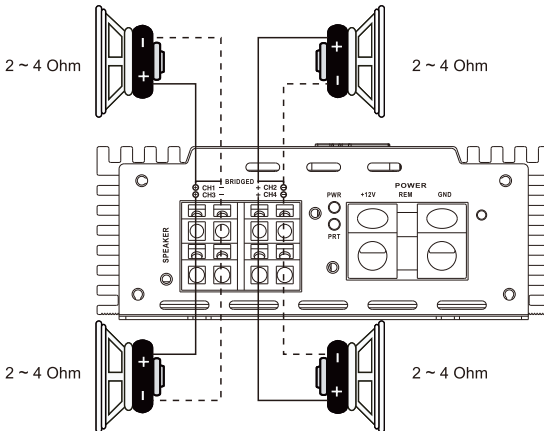

# VENOM-D5.80 IN

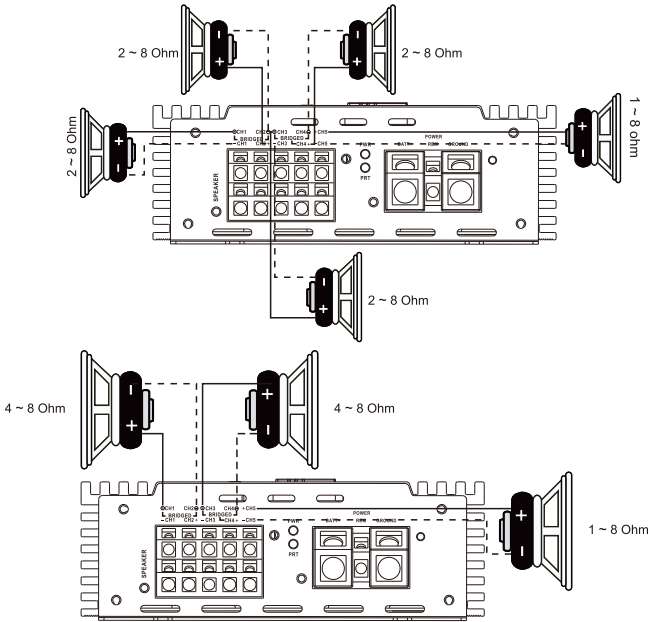

ENG

## TROUBLE SHOOTING

- ♦ AurA Venom series amplifiers have protection features to prevent any damages from misuse or faulty conditions.
- ♦ If Venom series amplifiers sense excessive heat, short circuited speakers DC, or voltage the protection indicator will light, and the system will be turned off.
- ♦ In order to check the problem, you should turn all levels down and all power off and carefully check the installation for wiring mistakes or short.
- ♦ If AurA Venom series amplifiers shuts down due to excessive heat, they will be working later when it is cooled down.
- ♦ Before removing your amplifier, refer to the list below and follow the suggested procedures.

### NO SOUND (NO OUTPUT)

- ♦ Please check all connections, cables' routing, short & voltage.
- ♦ Please check the fuses. If they are blown, please replace with new one.
- ♦ Please check whether speakers work well, you can test speakers by connecting to another amplifier

### DISTORTION & NOISE

- ♦ Readjust input level and check the speaker quality at another amplifier. Replace poor quality speakers with good quality ones.
- ♦ Check amplifiers and headunit's ground contact. All grounds should be common.
- ♦ Check RCA cable, then replace with new one or reroute RCA cable.
- ♦ Engine noise is caused by poor grounding of amplifiers, headunit, other components, battery or alternator, so please check all grounding connection.

### POOR BASS RESPONSE

- ♦ Please check speaker cables and reverse polarity.

CE EAC

**AURA**®

Follow us on:



[enigmatech.co.in](http://enigmatech.co.in)



[enigmatechnotronicx](https://www.instagram.com/enigmatechnotronicx)



[enigmadigital72](https://twitter.com/enigmadigital72)



[enigmadigitaltechno](https://www.facebook.com/enigmadigitaltechno)



[company/enigma-technotronicx](https://www.linkedin.com/company/enigma-technotronicx)

Enigma Technotronic Pvt Ltd.



A-5, Naraina Industrial Area New Delhi - 110028  
E: [info@enigmatech.co.in](mailto:info@enigmatech.co.in)